

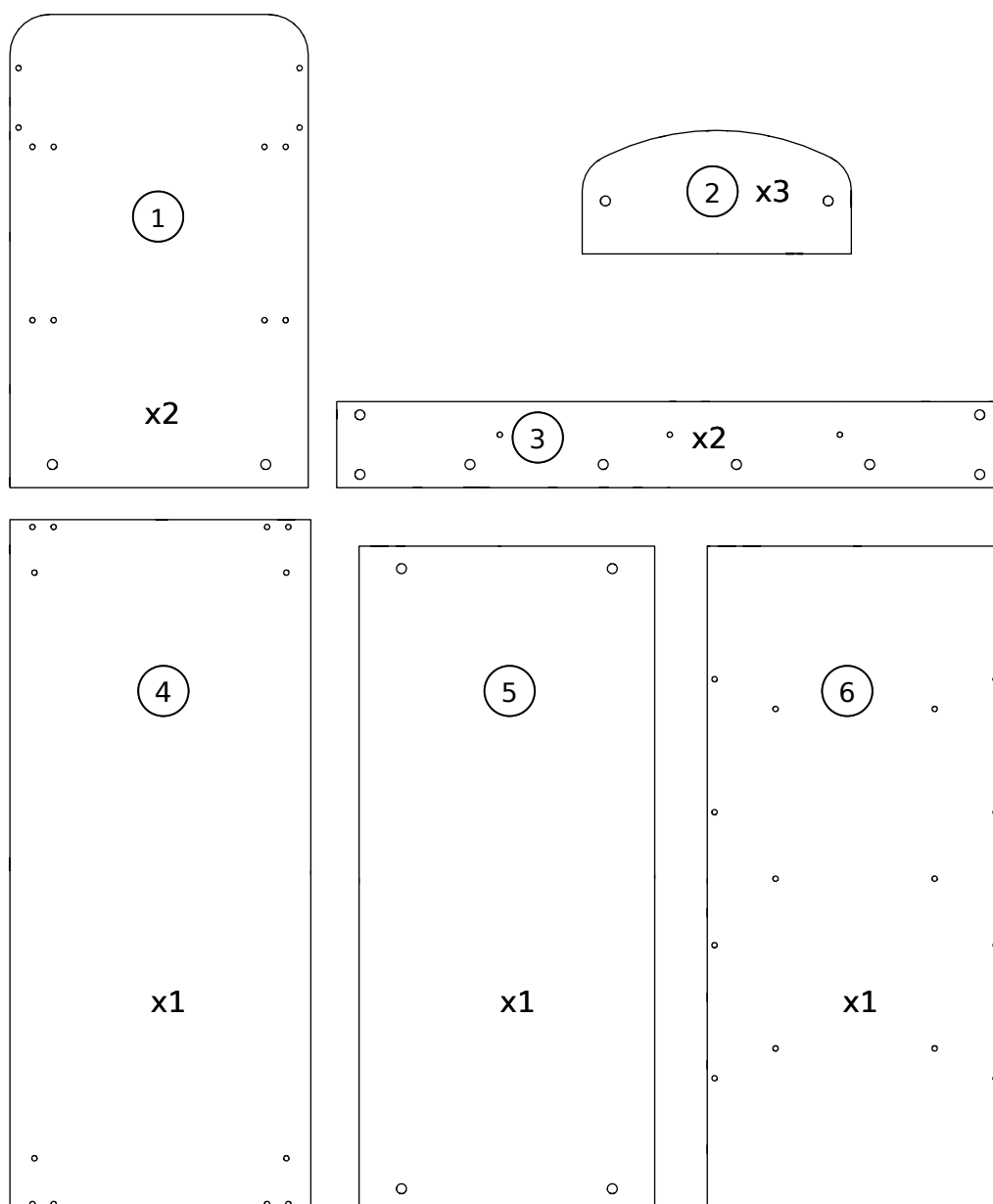

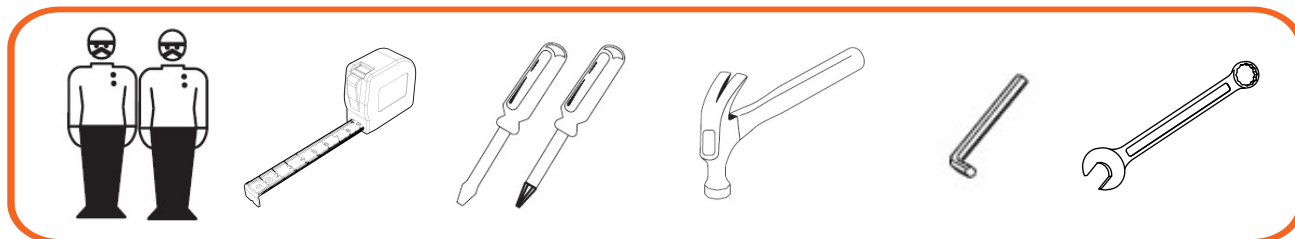



Instrukcja montażu Dwustronna biblioteczka na kółkach Primo 224

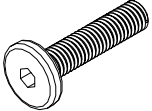

- | | | | |
|---------------|-------------|-------------------|-------------|
| 1 - bok | 715x450 mm | 4 - wieniec dolny | 1045x454 mm |
| 2 - przegroda | 406x190 mm | 5 - półka | 1005x446 mm |
| 3 - listwa | 1005x130 mm | 6 - wieniec górny | 1005x446 mm |

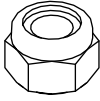
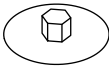
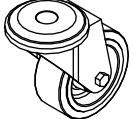
Nr.	Opis	Ilość		Nr.	Opis	Ilość	
A	Trzpień mimośrodowy	34		E	Śruba M8x35	4	
B	Zacisk mimośrodowy	34		F	Nakrętka M8	4	
C	Zaślepka	34		G	Kółko	2	
D	Kółko drewniany	18		H	Kółko z hamulcem	2	

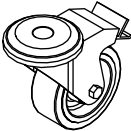
Trzpień mimośrodowy

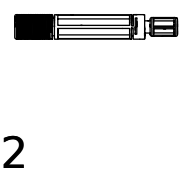

Zacisk mimośrodowy

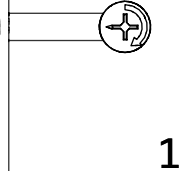

UWAGA!

Podczas montażu trzpienia i zacisku mimośrodowego, najpierw montujemy zacisk ze strzałką skierowaną w stronę otworu na trzpień, a następnie wciskamy trzpień do oporu.

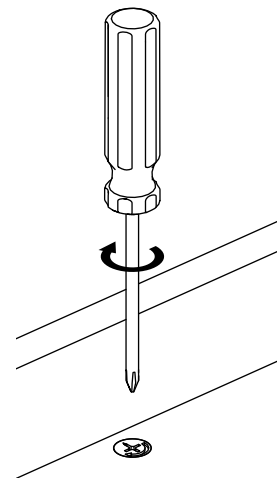

Po złączeniu elementów skręcanych, obrócić zacisk mimośrodowy do oporu w prawo.

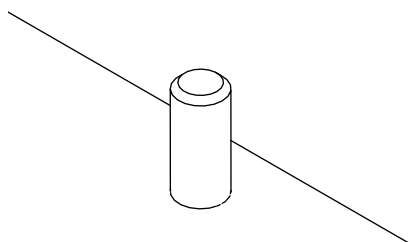

UWAGA!

Kółki drewniane montować na twardej powierzchni

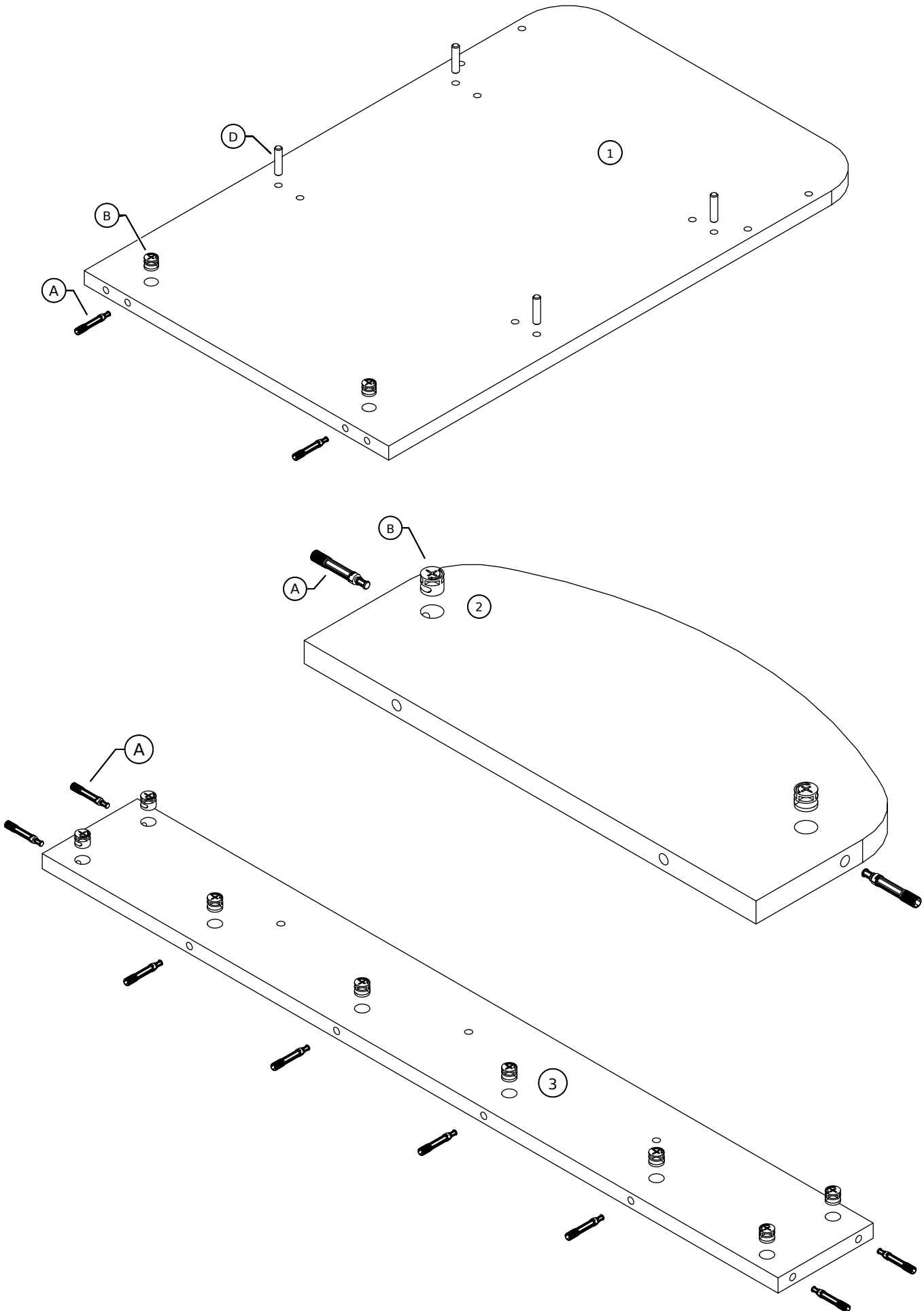

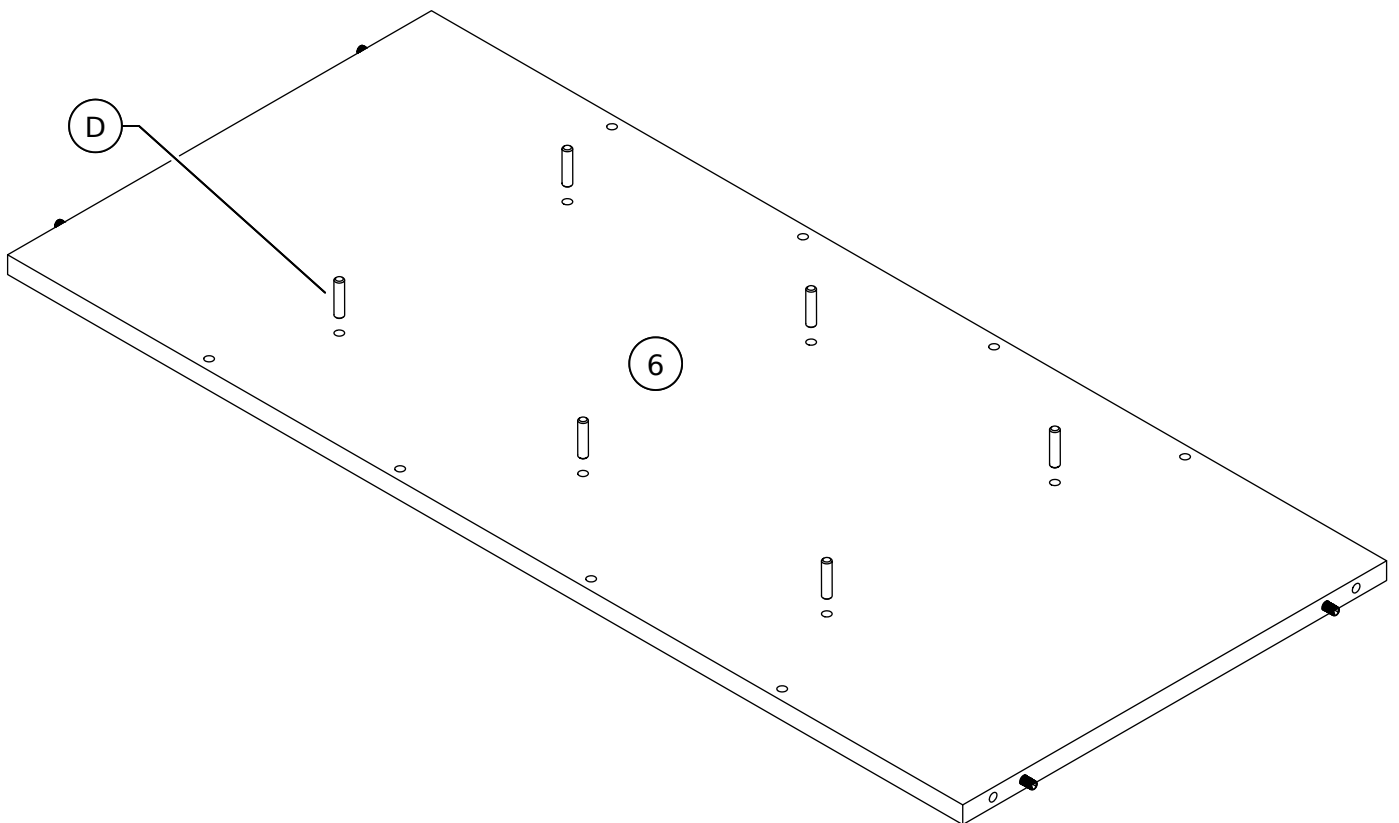
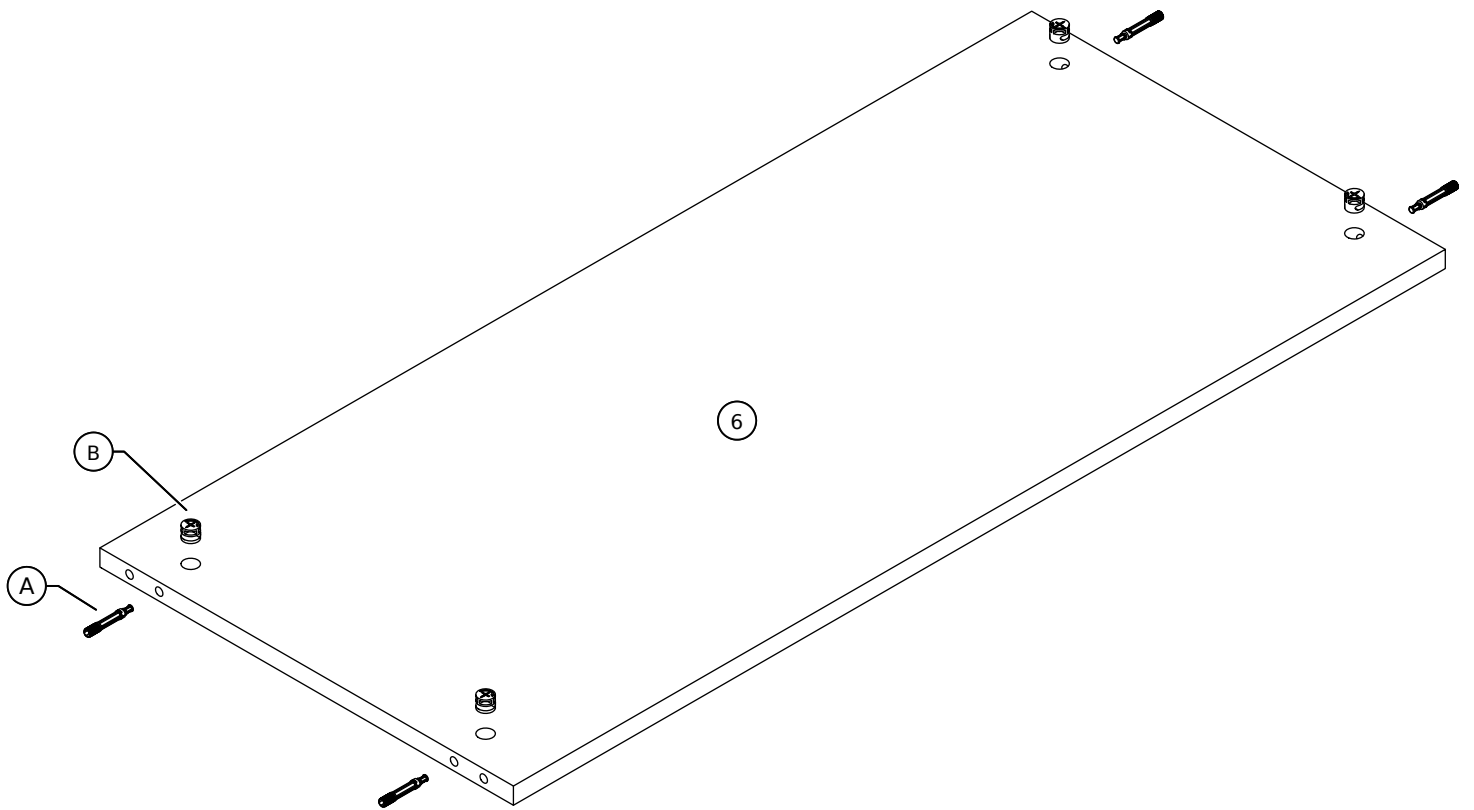

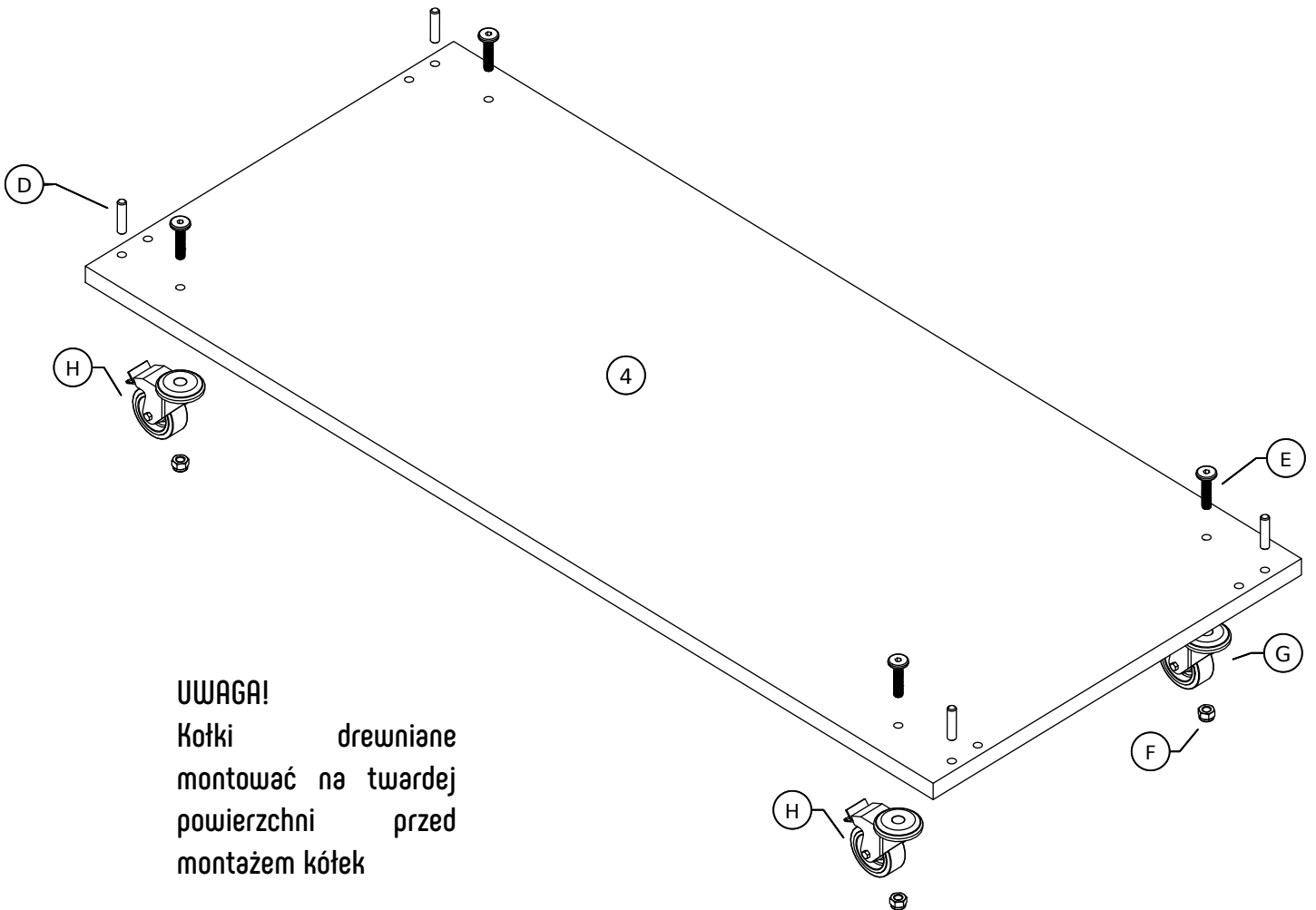
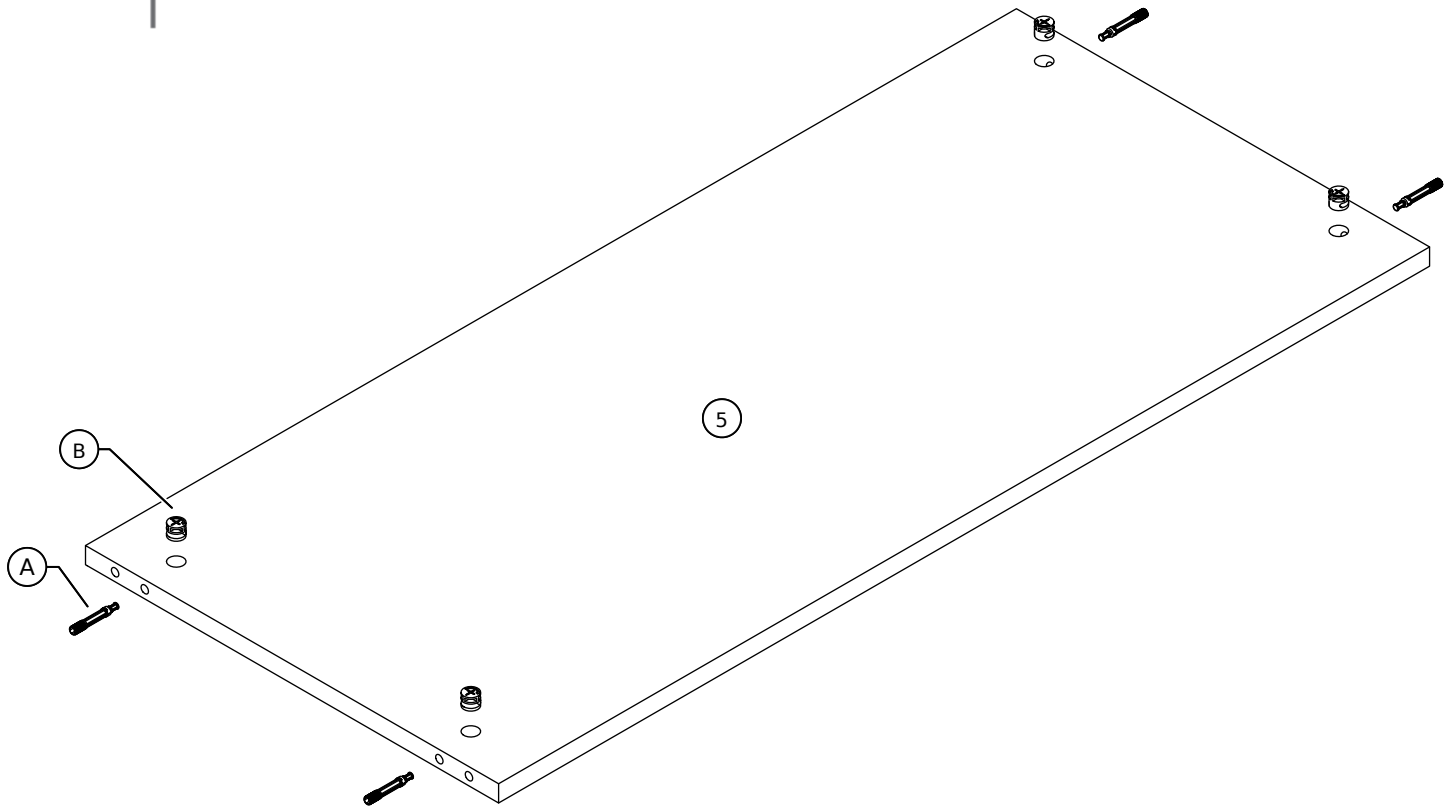

UWAGA!
Kołki drewniane
montować na twardej
powierzchni przed
montażem kótek

