

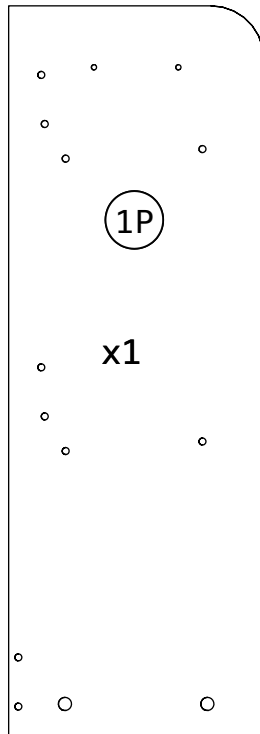

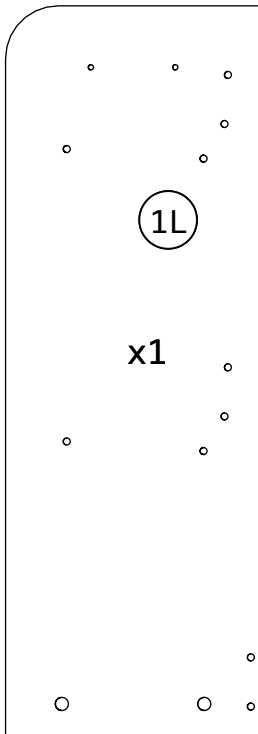

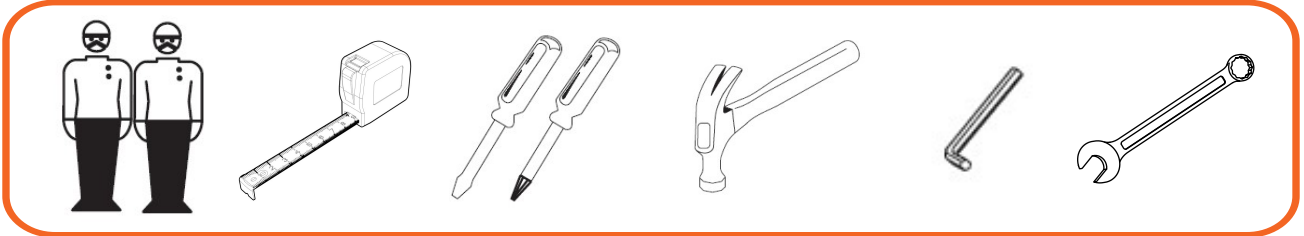

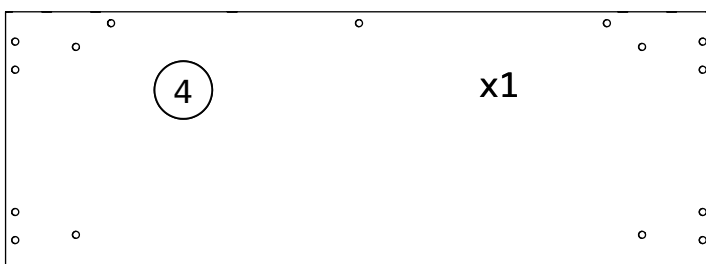

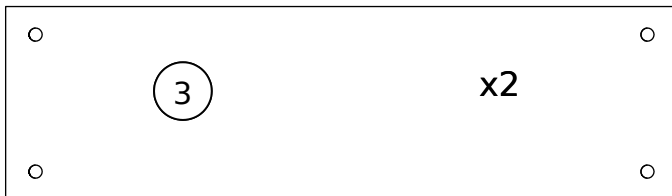
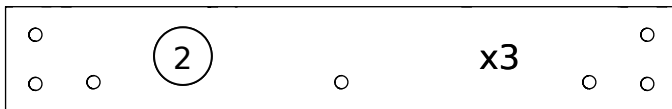

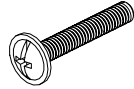
## Instrukcja montażu Regał mobilny do przewożenia książek Primo 226

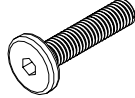

- |                   |            |
|-------------------|------------|
| 1L - bok lewy     | 830x290 mm |
| 1P - bok prawy    | 830x290 mm |
| 2 - tył           | 764x120 mm |
| 3 - półka         | 764x220 mm |
| 4 - wieniec dolny | 804x294 mm |

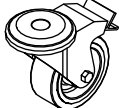

Nr.	Opis	Ilość		Nr.	Opis	Ilość	
A	Trzpień mimośrodowy	33		F	Śruba M4x25	4	
B	Zacisk mimośrodowy	33		G	Śruba M8x35	4	
C	Zaślepka	33		H	Nakrętka M8	4	
D	Kółko drewniany	4		I	Kółko	2	
E	Uchwyt	2		J	Kółko z hamulcem	2	

Trzpień mimośrodowy

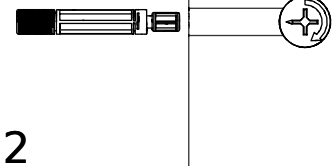

Zacisk mimośrodowy

1

2

**UWAGA!**

Podczas montażu trzpienia i zacisku mimośrodowego, najpierw montujemy zacisk ze strzałką skierowaną w stronę otworu na trzpień, a następnie wciskamy trzpień do oporu.

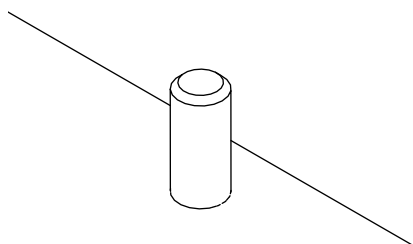

**UWAGA!**

Kółki drewniane montować na twardej powierzchni

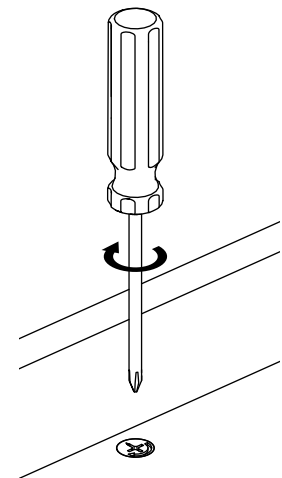

Po złączeniu elementów skręcanych, obrócić zacisk mimośrodowy do oporu w prawo.

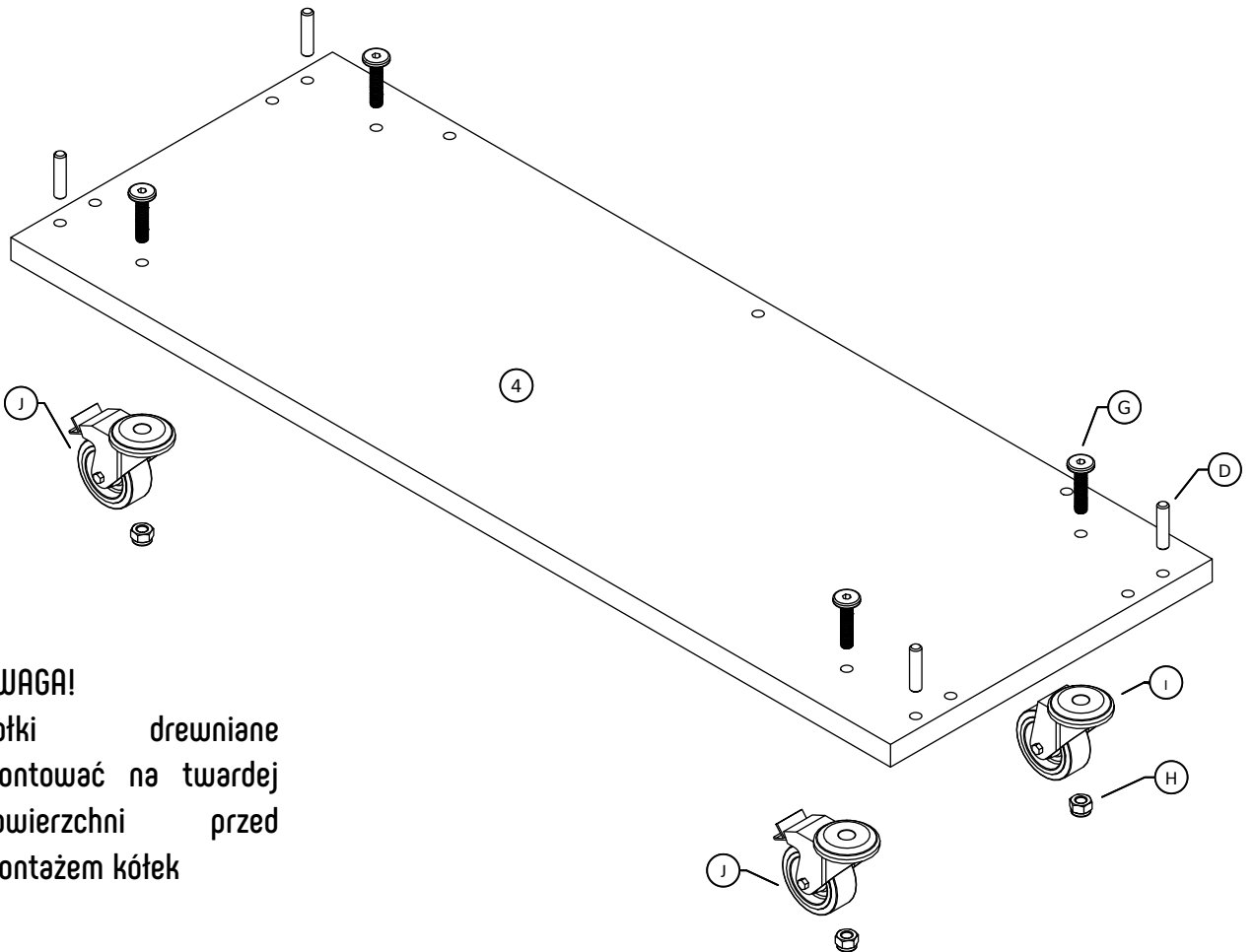
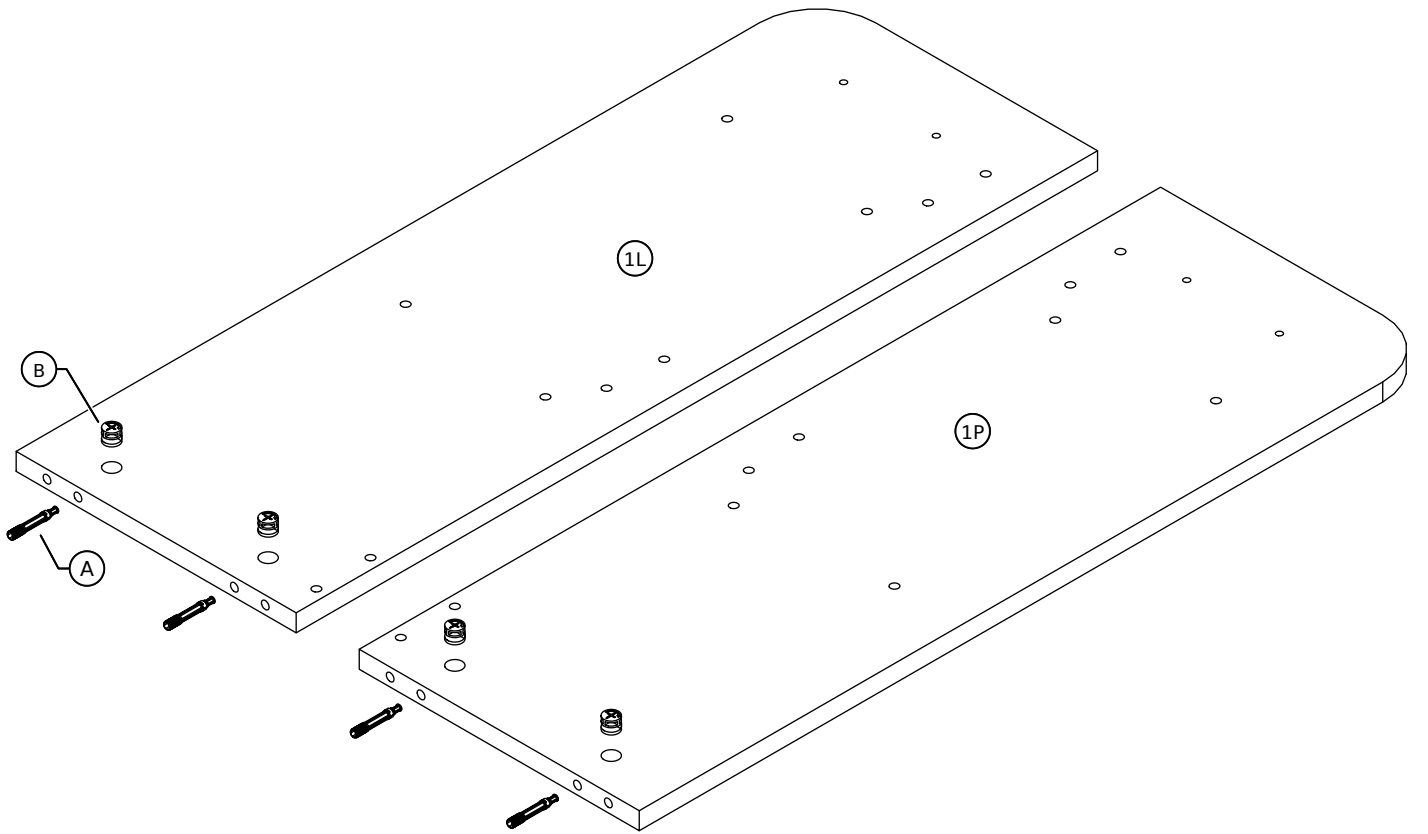

**UWAGA!**

Kotki drewniane  
montować na twardej  
powierzchni przed  
montażem kótek

